



MAGNETICALLY COUPLED CENTRIFUGAL PUMPS

VERTICAL CENTRIFUGAL IMMERSION PUMPS

FILTERS AND FILTER EQUIPMENT

RM-TS PUMPS – THE FIRST MAGNETICALLY COUPLED CENTRIFUGAL PUMPS IN THE WORLD WITHOUT SLEEVE BEARINGS THAT ARE ABSOLUTELY SAFE TO RUN DRY



THE RM-TS SERIES

includes pumps from the RM2-TS type with a maximum delivery rate of 29 GPM, 33 feet of head and a 0.5 HP motor, to the RM5-TS type with a maximum delivery rate of 396 GPM, 197 feet of head and a 15 HP motor.

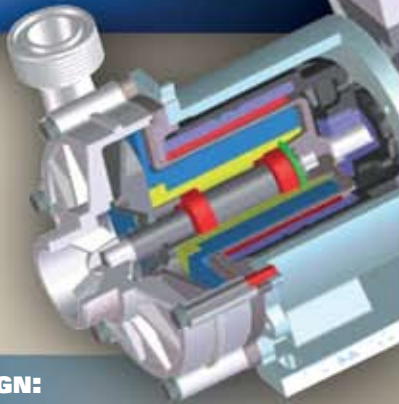

SIMPLE AND RELIABLE DESIGN:

No sleeve bearings.

Extremely high resistance to chemicals.

All RM type pumps can be offered in the new dry run (TS) design.

1750 or 3450 rpm motors available.

The ceramic bearings have an extremely low coefficient of friction dramatically increasing pump efficiency.

AT LAST A PUMP THAT IS ABSOLUTELY SAFE TO RUN DRY!

Conventional magnetically coupled pumps can hardly cope with dry running. In fact, their sleeve bearings need continuous liquid-film lubrication to keep bearing friction and the resulting frictional heat as low as possible and also to provide the bearing with sufficient cooling.

With its pumps of the RM-TS type, Renner offers the first magnetically coupled centrifugal pumps in the world that are absolutely safe to run dry.

This new "TS" range includes all the advantages of the existing RM type with the additional certainty that they will not be damaged by dry running. The coefficient of friction of the new RM-TS bearing is so small that only a minimum of heat is generated. Therefore, the bearing does not require any liquid lubrication. All wet-end components of the pump head are still metal-free and made exclusively of materials that assure maximum chemical resistance against aggressive fluids.

Renner sealless pumps will not leak, are hermetically sealed, and maintenance-free.

CHOOSING THE RIGHT PUMP GUARANTEES SAFE AND RELIABLE OPERATION.

CHOICE OF PUMPS

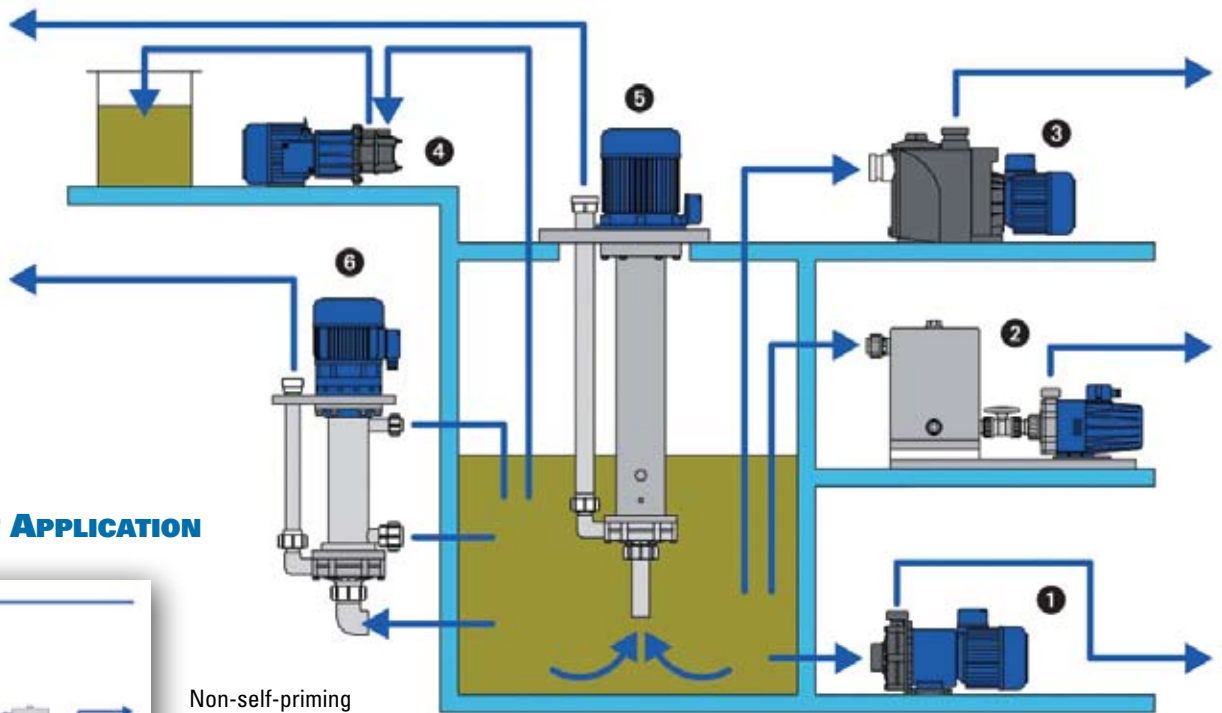

RANGES OF APPLICATION

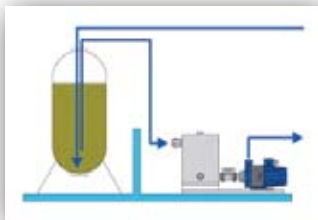

Non-self-priming centrifugal RM pump with extra priming tank

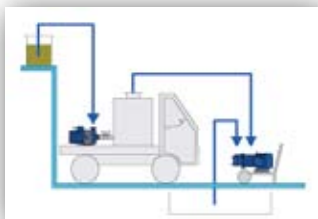

Installation on a transport vehicle

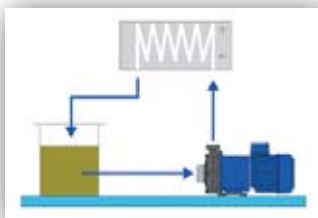

Non-self-priming centrifugal RM pump with heat exchanger

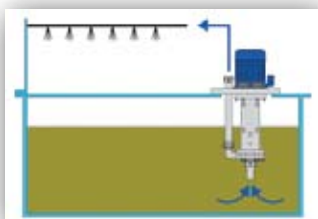

Centrifugal immersion pump of the RT type

- 1 Non-self-priming magnetically coupled centrifugal pumps of the RM type
- 2 Non-self-priming magnetically coupled centrifugal RM pumps with extra priming tank
- 3 Self-priming magnetically coupled centrifugal pumps of the RMB type
- 4 Self-priming side-channel pumps of the RMS type
- 5 Vertical centrifugal immersion pumps of the RT type for wetpit operation
- 6 Vertical centrifugal immersion pumps of the RTA type for dry-well installation

RM MAGNETICALLY COUPLED CENTRIFUGAL PUMPS WITHOUT SHAFT SEAL

NON-SELF-PRIMING CENTRIFUGAL PUMPS



RM 1

Delivery rate
1 to 9.5 GPM

Delivery head
up to 16 feet



RM 1.5

Delivery rate
1 to 22 GPM

Delivery head
up to 23 feet



RM 2

Delivery rate
1.3 to 34 GPM

Delivery head
up to 30 feet



RM 2D

Delivery rate
1 to 16 GPM

Delivery head
up to 52 feet



RM 3

Delivery rate
2 to 60 GPM

Delivery head
up to 75 feet



RM 4

Delivery rate
2 to 106 GPM

Delivery head
up to 118 feet



RM 4.5

Delivery rate
5 to 238 GPM

Delivery head
up to 115 feet



RM 5

Delivery rate
8 to 330 GPM

Delivery head
up to 197 feet

SELF-PRIMING SIDE-CHANNEL PUMPS



RM 2.1

Delivery rate
1 to 6 GPM

Delivery head
up to 177 feet
Suction head
up to 23 feet

SELF-PRIMING WITH INTEGRATED PRIMING TANK



RM 3.1

Delivery rate
2 to 63 GPM

Delivery head
up to 59 feet
Suction head
up to 11.5 feet

MINI MAG DRIVE



RM Cool 0.5

Delivery rate
up to 1.3 GPM

Delivery head
up to 6.5 feet

The magnetically coupled centrifugal mini-pump of the RM-Cool type is the ideal high-performance cooling system to remove heat from laser devices, computers, plasma-arc cutters etc. Made of PP, PPS or PVDF.

THE FOLLOWING MATERIALS ARE AVAILABLE FOR RM PUMPS:

MATERIAL

TEMPERATURE RANGE

Components in contact with the fluid

Polypropylene (PP)	0 to +176°F
Polyvinylidene fluoride (PVDF)	-4 to +203°F
Polyphenylene sulphide (PPS)	-4 to +212°F
Stainless steel (1:4305, 1:4571)	-4 to +212°F
Oxide ceramic (aluminium oxide 99.7%)	-4 to +212°F
PTFE graphite	-4 to +212°F

O-Rings

Ethylene-propylene-diene rubber (EPDM)	-4 to +212°F
Fluorinated rubber (FKM)	-4 to +212°F
Perfluoroethylene copolymer (FEP coated)	-4 to +212°F
Nitrile-butadiene rubber (NBR)	-4 to +212°F

CHARACTERISTIC CURVES OF RM-TYPE PUMPS

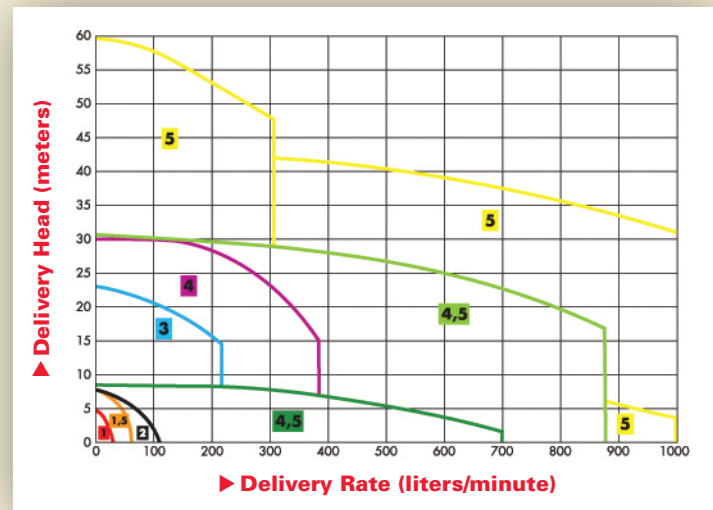

- Heavy-duty durable design
- Neodymium magnets
- True union connections
- NPT, flange, hose
- Motors: TEFC 1.25SF
- XP + special enclosures available
- Thrust bearings for all conditions
- Hydraulically balanced shafts
- ISO 9001
- Each unit individually tested and certified

RT CENTRIFUGAL IMMERSION PUMPS FOR WET-PIT AND DRY-WELL INSTALLATION

RT IMMERSION PUMPS FOR WET-PIT OPERATION (FOR DRY-WELL INSTALLATION WITH IDENTICAL FEATURES)



RT 1

Delivery rate
up to 8 GPM

Delivery head
up to 15 feet

Immersion depth
8 to 19 inches



RT 2

Delivery rate
up to 24 GPM

Delivery head
up to 26 feet

Immersion depth
8 to 20 inches



RT 3

Delivery rate
up to 61 GPM

Delivery head
up to 65.5 feet

Immersion depth
8 to 21 inches



RT 4

Delivery rate
up to 92 GPM

Delivery head
up to 115 feet

Immersion depth
10 to 20 inches



RT 5

Delivery rate
up to 158 GPM

Delivery head
up to 131 feet

Immersion depth
11 to 19 inches



RTM magnetically coupled centrifugal immersion pumps

Delivery rate
up to 106 GPM

Delivery head
up to 131 feet

Immersion depth
10 to 79 inches

FILTER TECHNOLOGY BY RENNER – HIGHEST LEVEL PERFORMANCE

RENNER QUICK-CHANGE FILTER SF



SF1

Made of PP or PVDF

Insert slots for wound cartridges, filter sieves and bags or activated carbon.

Lever-operated quick-release. Double safety switch in the filter cap.



SF2

Made of PP or PVDF

Insert slots for wound cartridges, filter sieves and bags or activated carbon.

Lever-operated quick-release. Double safety switch

RENNER FILTER UNITS WITH IMMERSION PUMPS

RENNER FILTER UNITS WITH IMMERSION PUMPS



RT immersion pump combined with a filter housing of type 1

Flow rate up to 1,585 GPH

Immersion depth 8 to 19 inches



RT immersion pump combined with a quick-change filter

Delivery rate up to 4,755 GPH

Immersion depth 10 to 19 inches

Type 1.1 protects from dry-running.

Type 1.5 protects from dry-running and overheating.

Type 2 monitors the pump and the pressure drop of the filter.



ELECTRONIC PUMP PROTECTORS AND FILTER MONITORS

Electronic monitoring of motor currents reliably protects the pump from dry running, overheating and overload.

If the above mentioned malfunctions cannot be completely ruled out with your installation, you should use an electronic protector to switch off the pump before it

is damaged. Such protectors will not only avoid damage to the pump, but also down time and costs resulting thereof. Once the cause of the malfunction is eliminated, the pump is immediately ready to continue operation.

Electronic pump protectors and flow monitors come in three designs. Type 2 also monitors the pressure drop of the filter and indicates a clogged filter.



MARKETS:

Printed circuit board

Semi conductor

Plating

WWT

OEM

CPI

Textile

Automotive

Pharmaceutical

More

FLUX PUMPS CORPORATION

4330 Commerce Circle

Atlanta, GA 30336

Phone: 404-691-6010

1-800-367-3589

Fax: 404-691-6314

Info: webmaster@flux-pumps.com

www.flux-pumps.com